



THANK YOU FOR PURCHASING YOUR 3 DOOR METAL LOCKER UNIT.

Please carefully read and follow these instructions to assemble your cabinet.

ENSURE PROTECTIVE EYEWEAR AND GLOVES ARE WORN WHEN ASSEMBLING THIS UNIT.

WARNING: SERIOUS INJURY CAN BE CAUSED BY TOPPLING FURNITURE. To help prevent tip-over, we recommend you anchor this product to a wall or other suitable surface. Check anchors regularly.

Step 1

FITTING SIDE PANELS TO BACK PANEL

A

Screw together back panel and left hand side panel at locations indicated by the arrows.

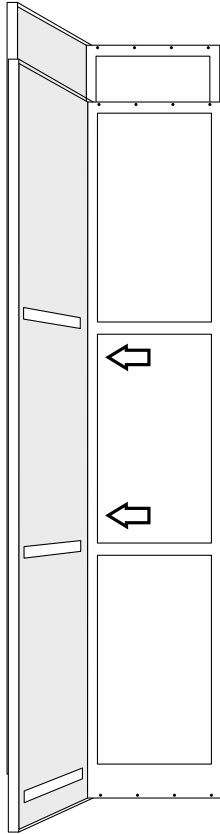

B

Screw together back panel and right hand side panel at locations indicated by the arrows.

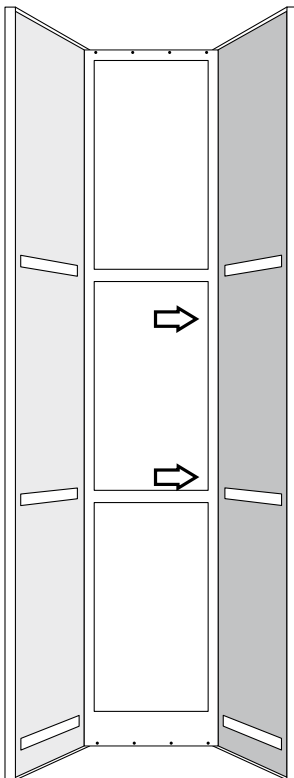

Step 2

FITTING FRONT DOOR PANEL TO SIDE PANELS

C

Slot front door panel into one side then into the other.

Note: Ensure the front door panel is flush with the side panels. This is easier to do with the doors open.

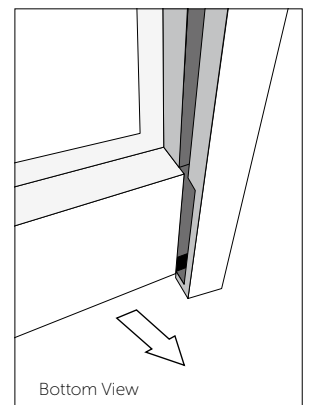
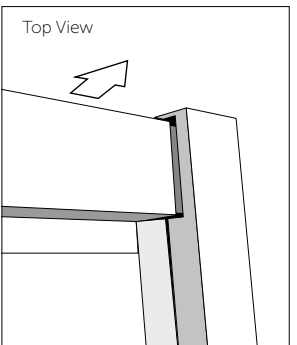
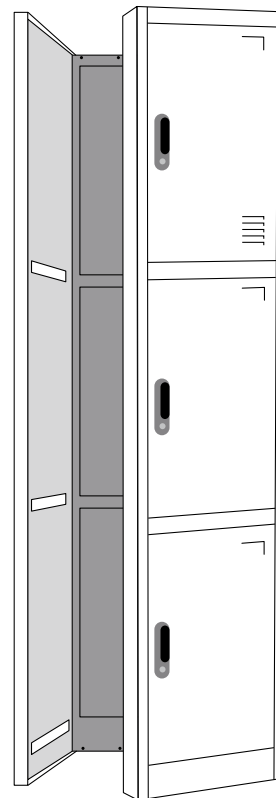
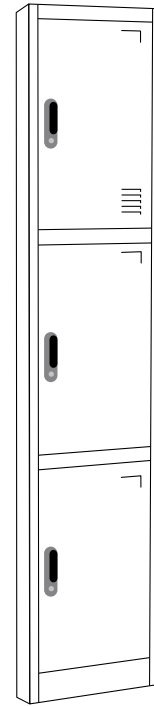

Step 3

FITTING THE TOP PANEL

D Slide the top panel inside the cabinet and push up until flush with the top of panels.

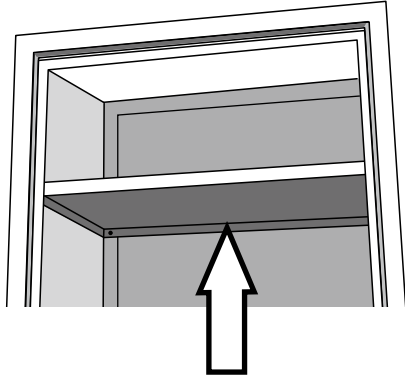

E Screw the top panel to the inside of the cabinet as indicated by the arrows.

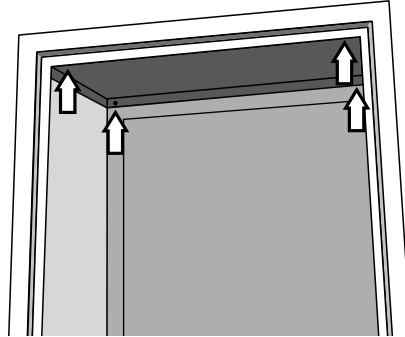

Step 4

FITTING THE BOTTOM PANEL TO THE CABINET

F Push the floor panel down inside the cabinet ensuring the sides of the floor slide into the slots on the side and back panels.

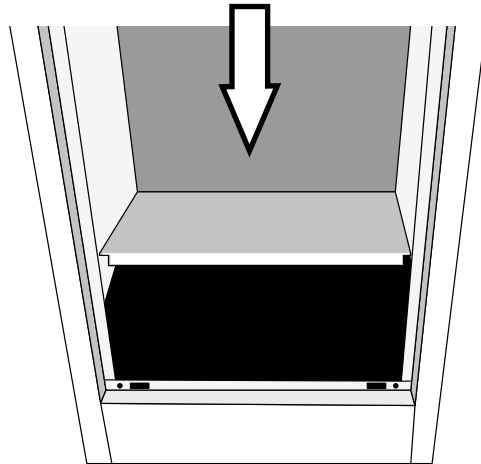

G Ensure that the tab on the bottom panel fits over the lip on the front panel and clips into place.

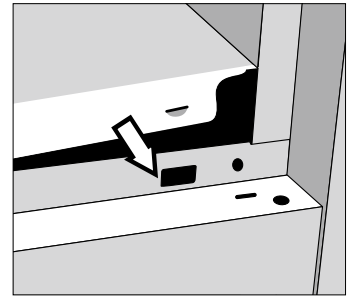

Step 5

FITTING THE LOCKER BASE PANELS x2

H Insert the locker base panels from the inside of the cabinet.

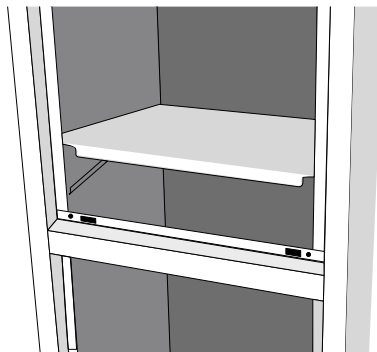

I Ensure that the tab on the locker base panel fits over the lip on the front panel and clips into place.

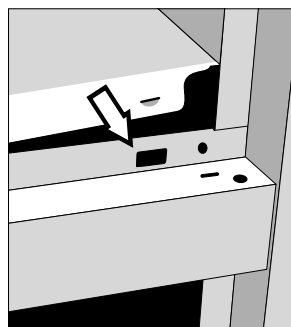

Finished size:
1850 x 380 x 450mm

